

*detal 1-1*

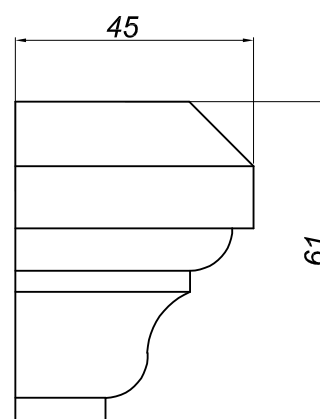

detal 1-2

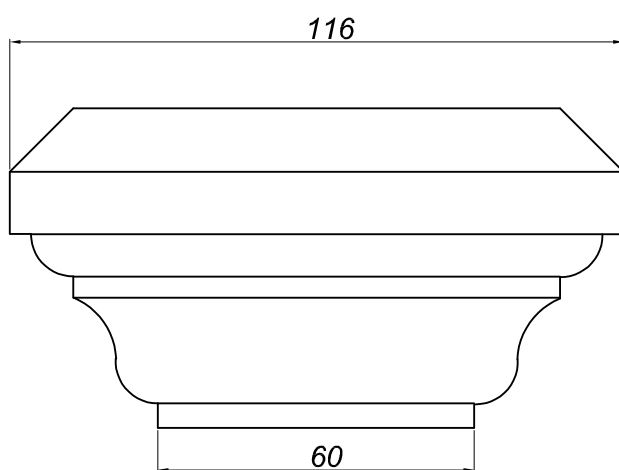
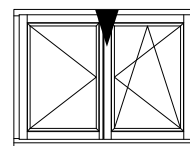
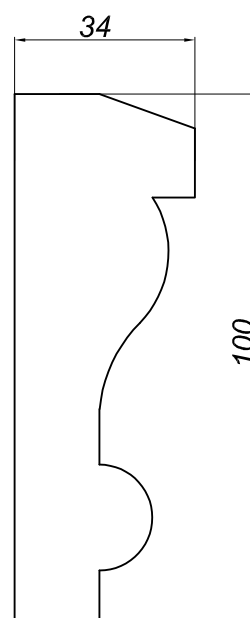
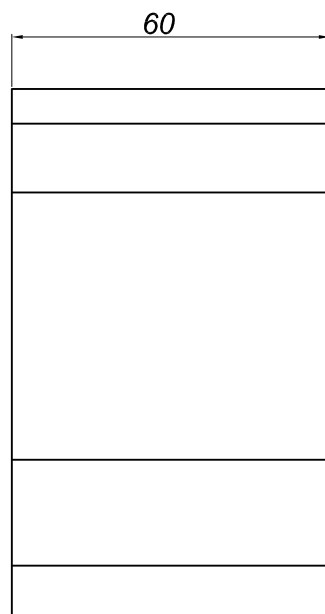
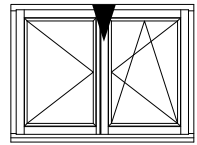

*detal 1-3*

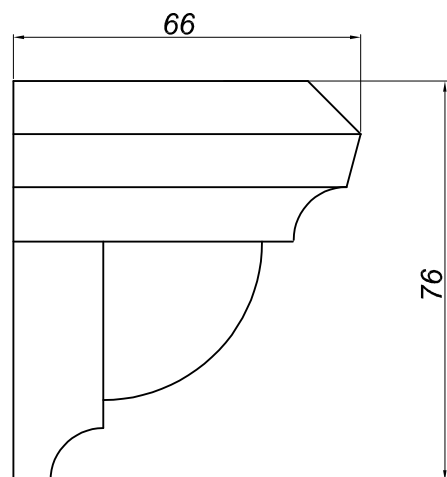
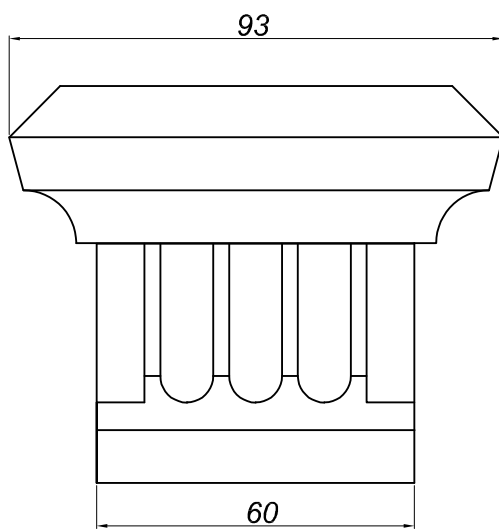
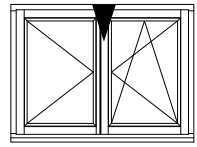

*detal 1-4*

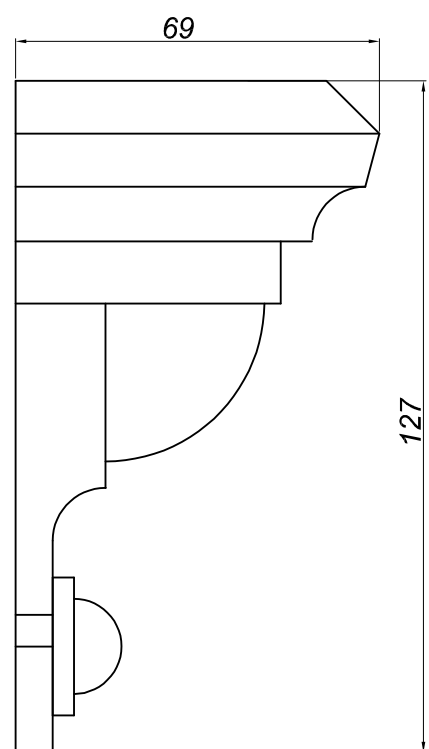
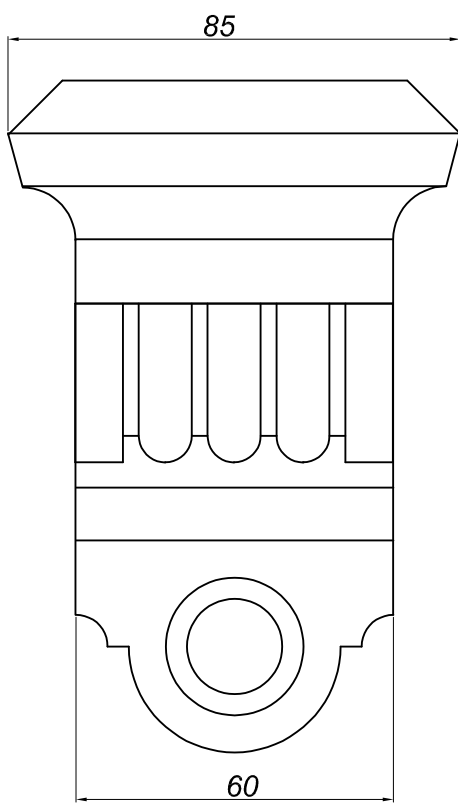
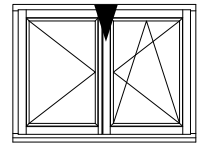

*detal 1-5*

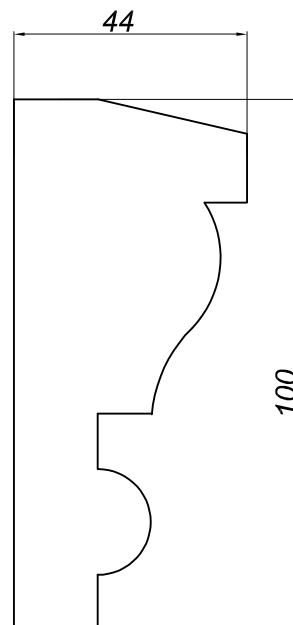
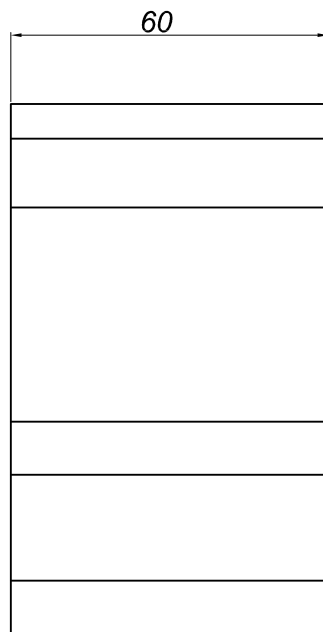
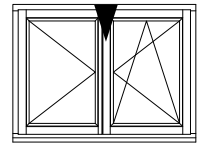

*detal 1-6*

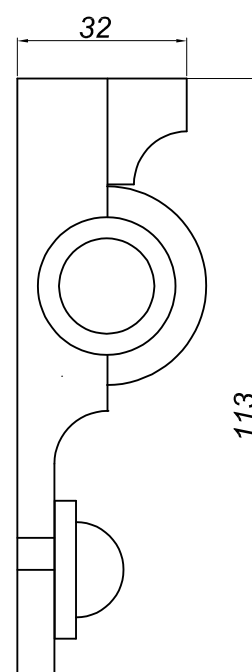
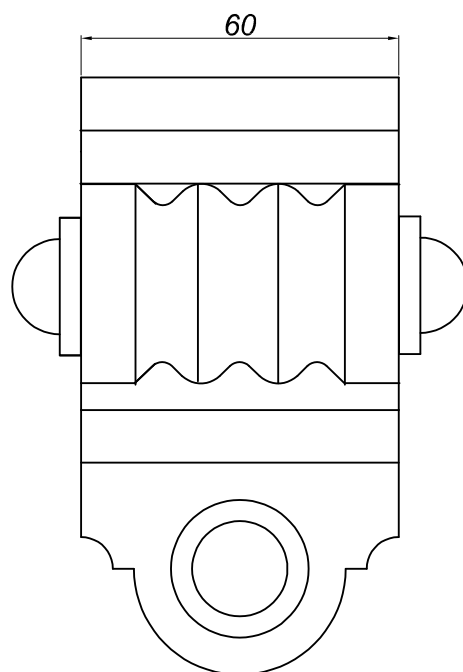
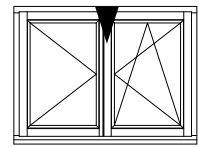

*detal 1-7*

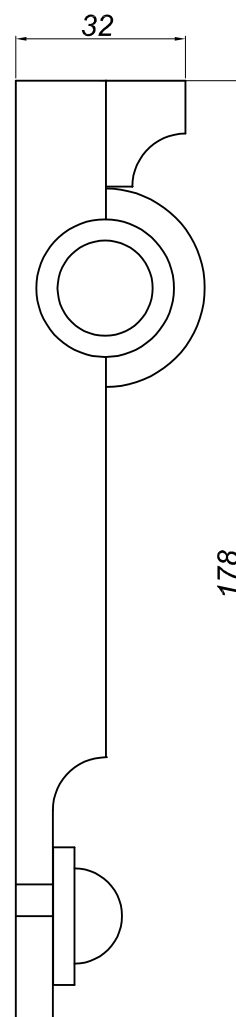
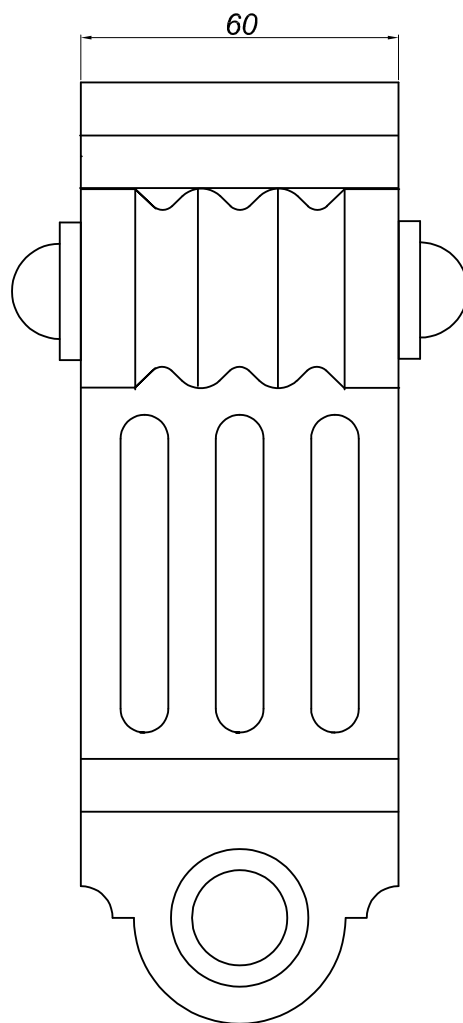
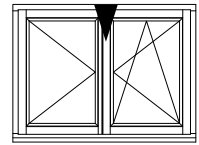

*detal 1-8*

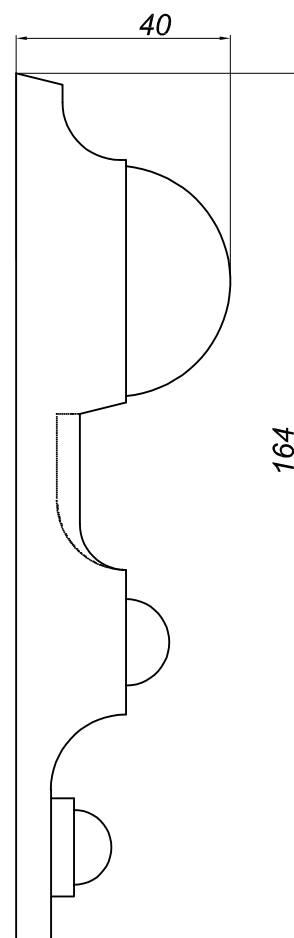
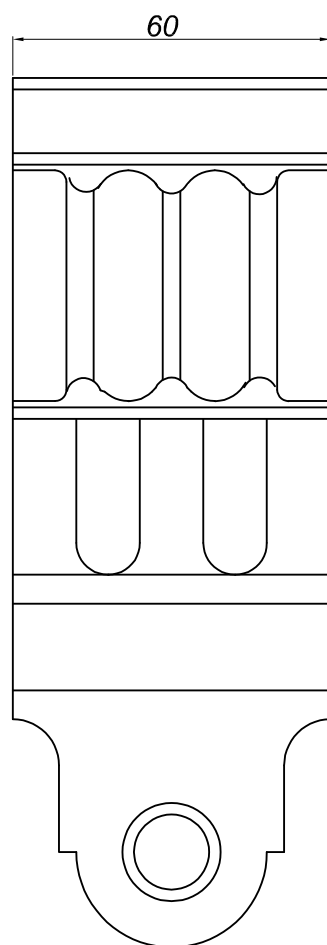
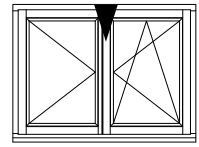



detal 1-9

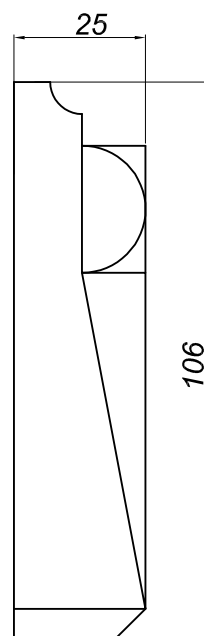
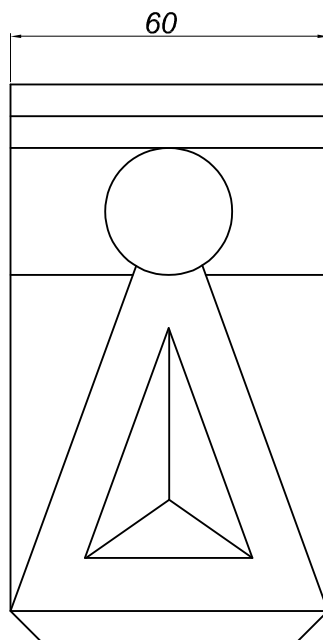
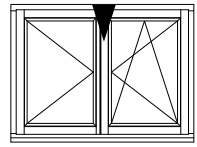

*detal 1-10*

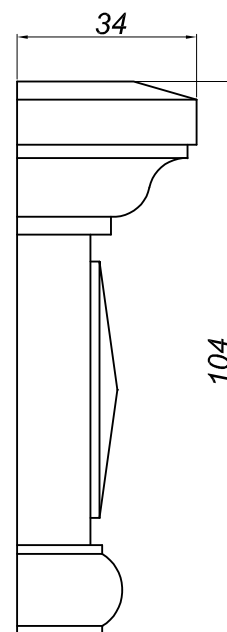
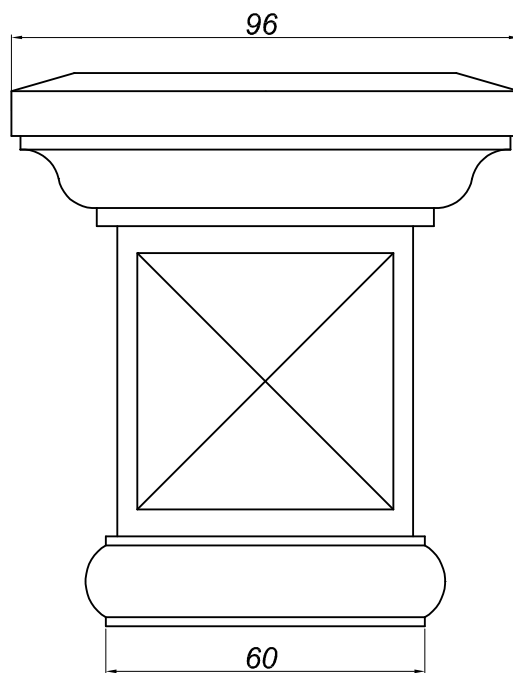
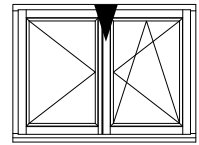

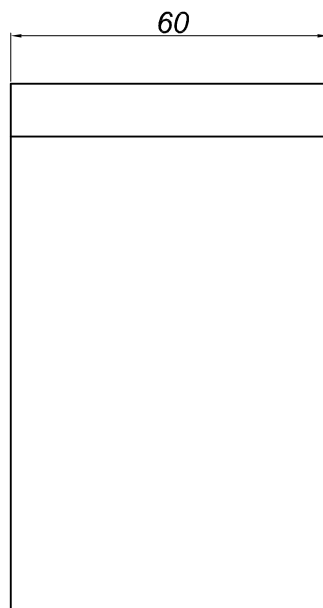
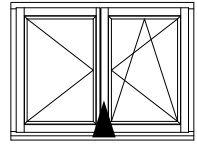
*detal 1-11*

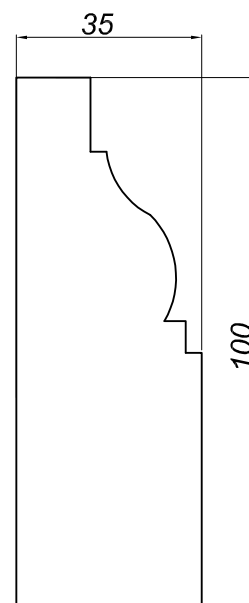
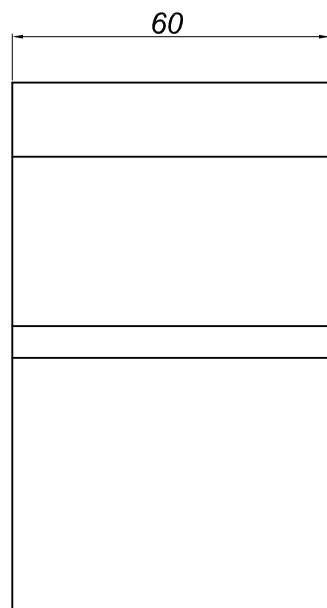
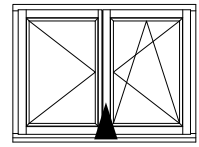
*detal 1-12*

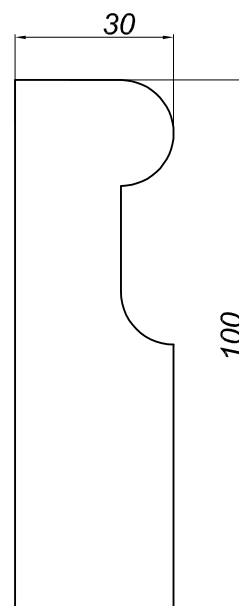
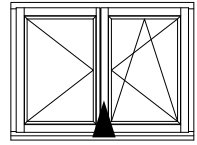
*detal 1-13*

*detal 1-14*

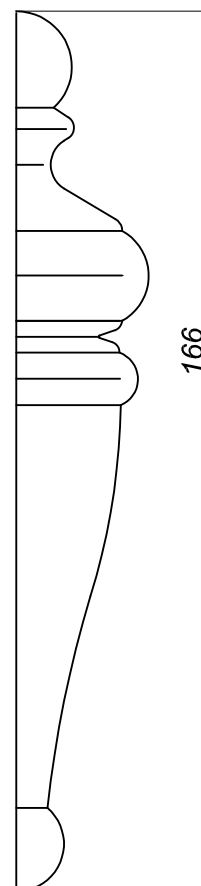
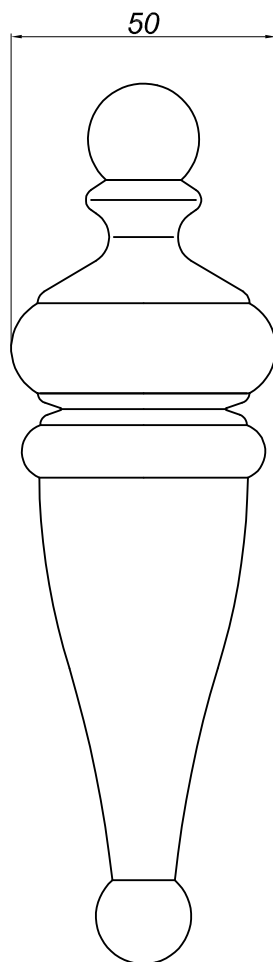
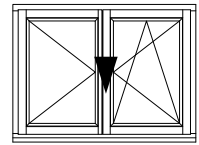

*detal 1-15*

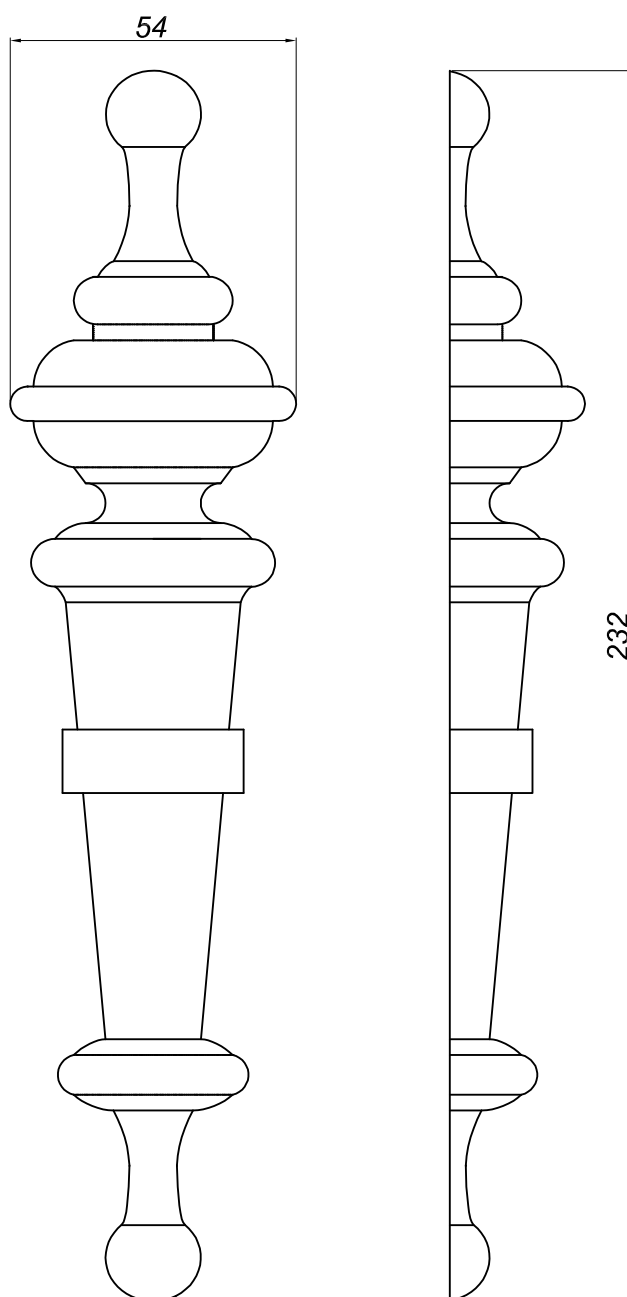
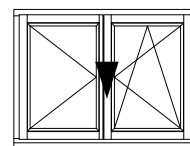

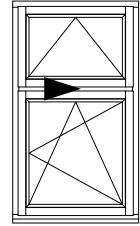
*detal 1-16*

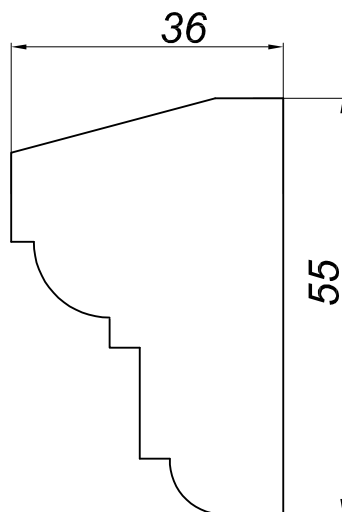
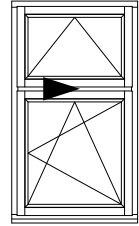

*detal 1-17*

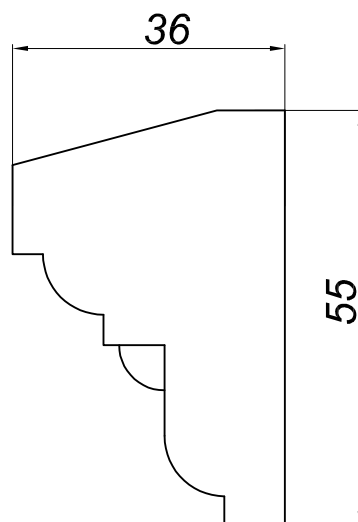
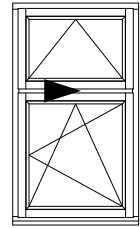
*detal 1-18*

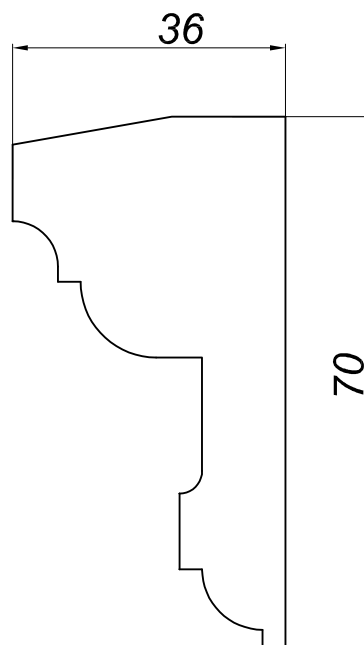
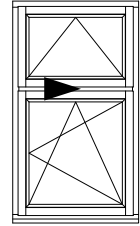
*detal 1-19*

detal 1-20

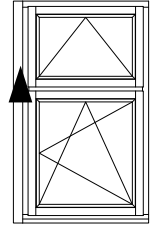

strona zewnętrzna

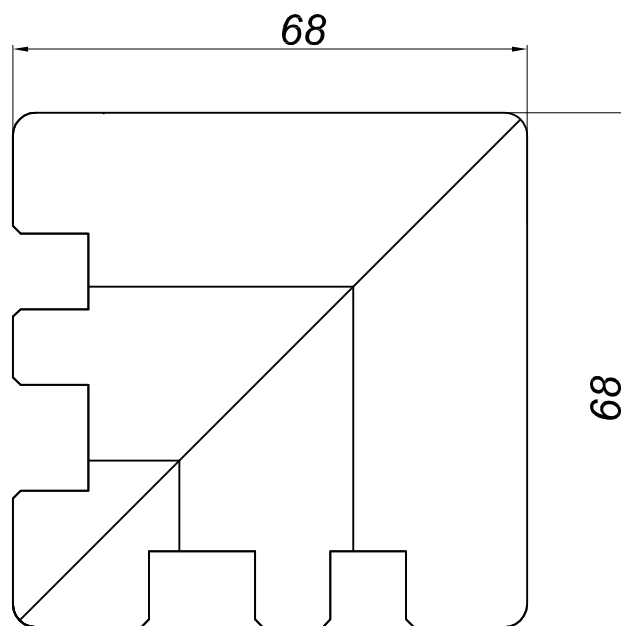

detal 1-21

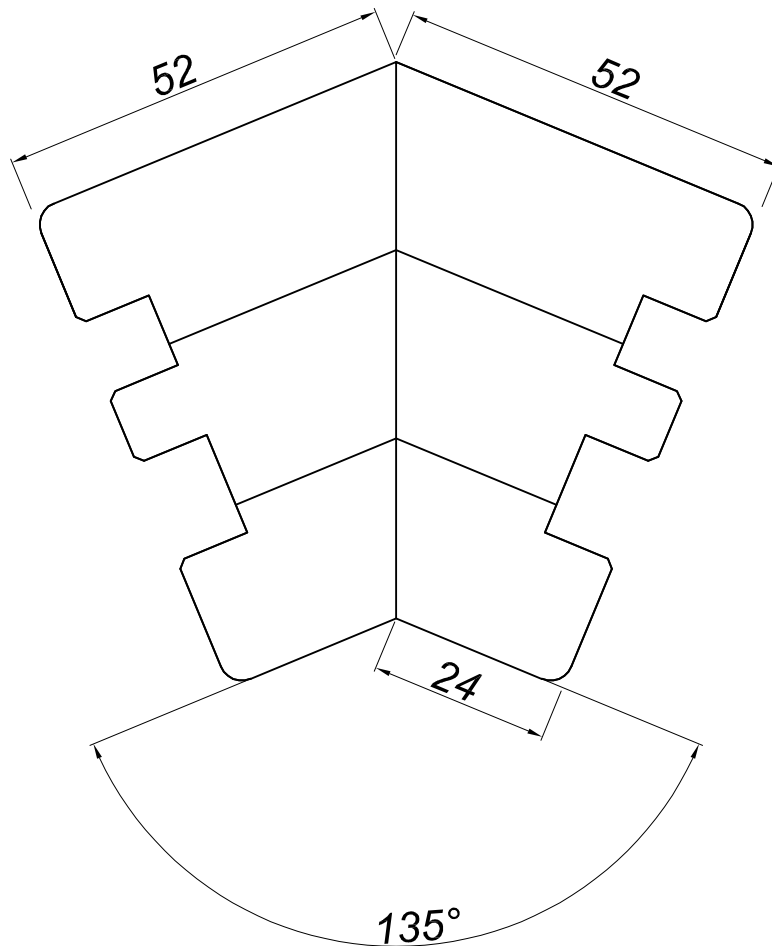
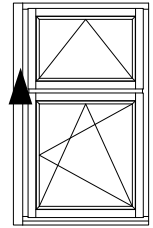

detal 1-22

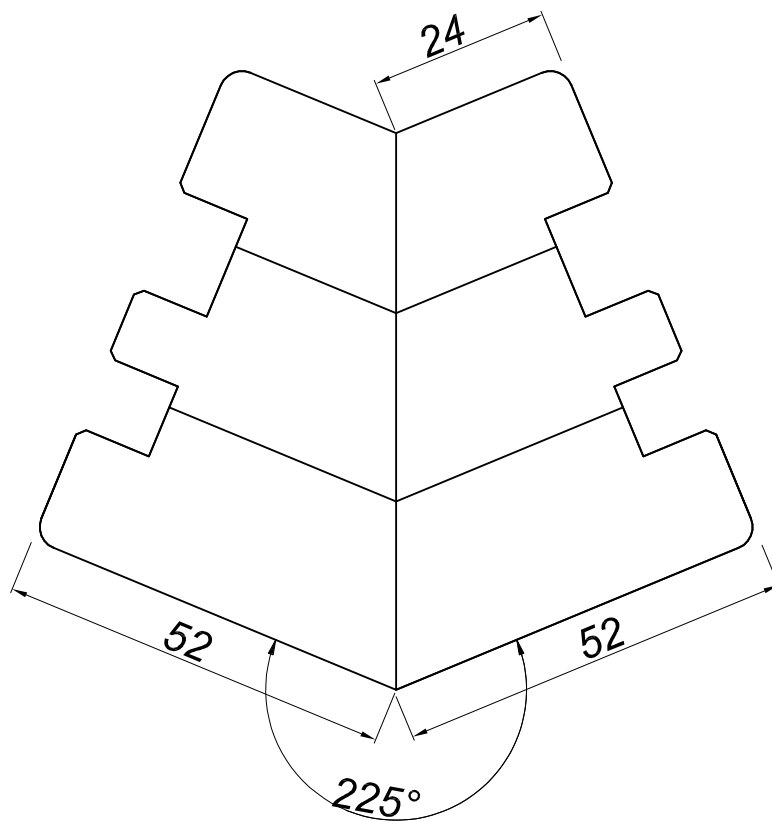
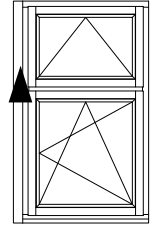

*detal 1-23*

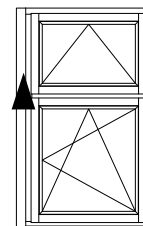

strona zewnętrzna

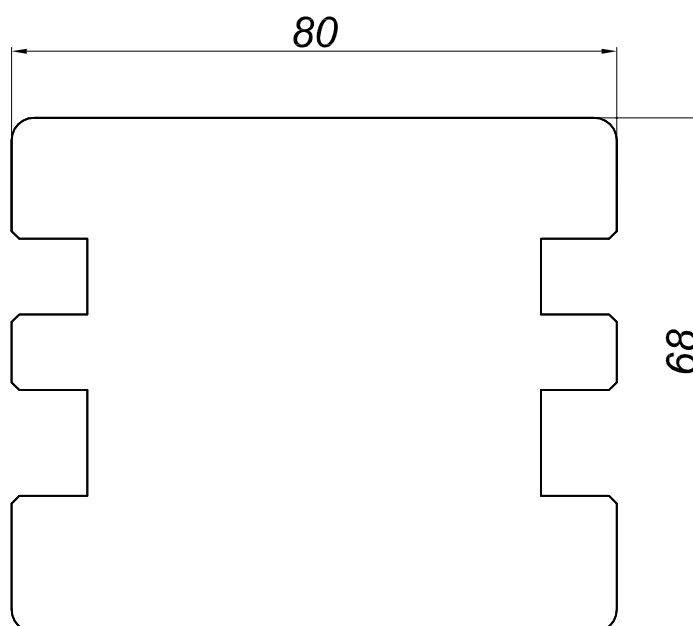

*detal 1-24*

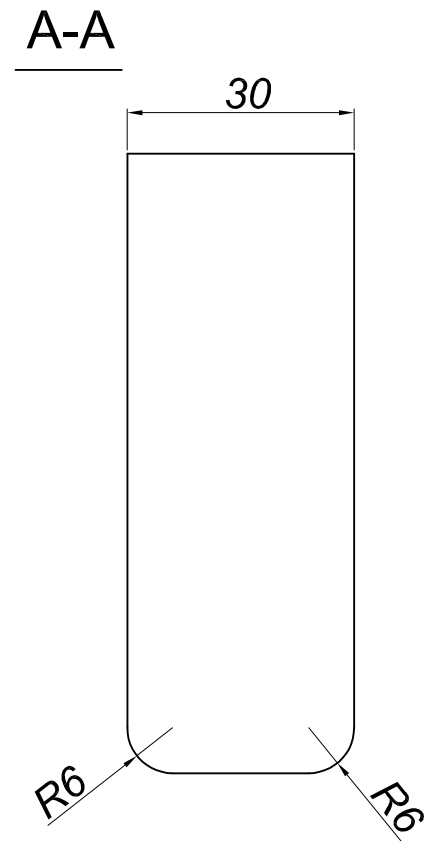
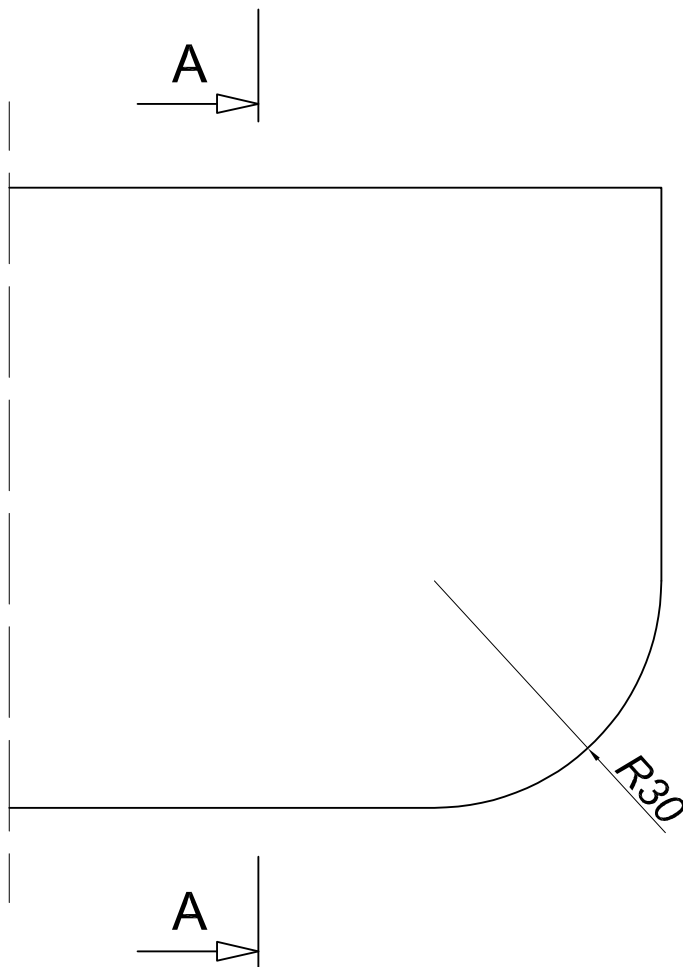
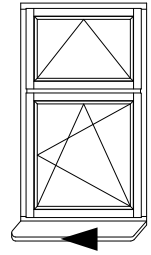



detal 1-25

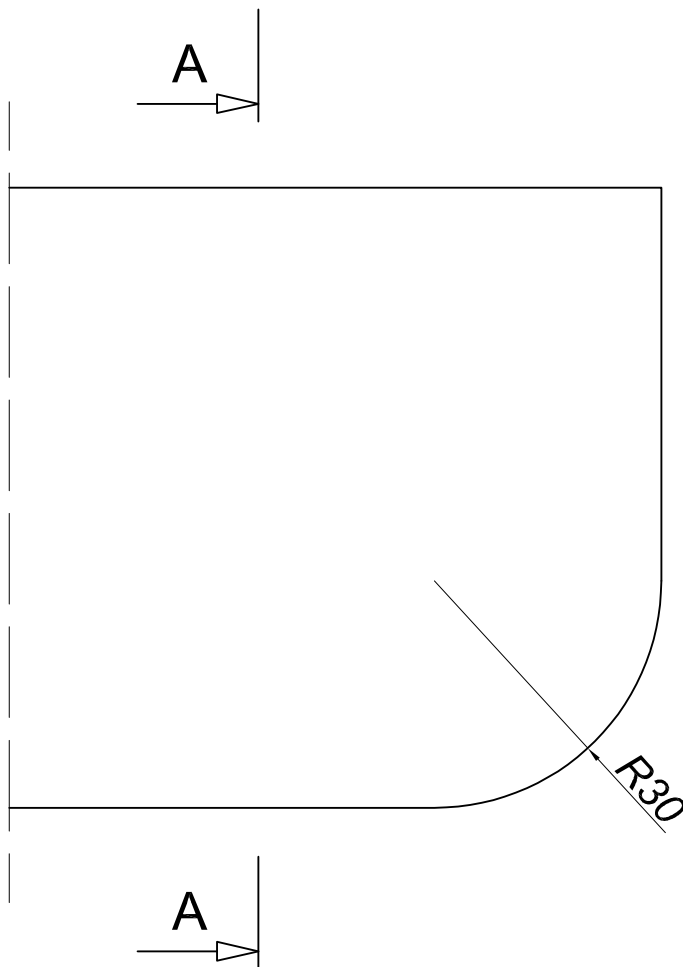
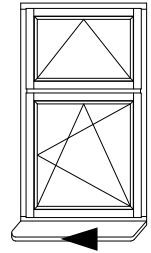

A-A

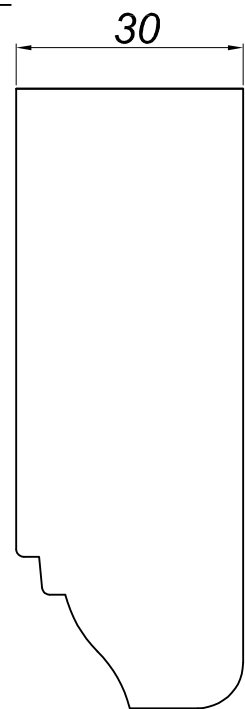

powierzchnia widoczna

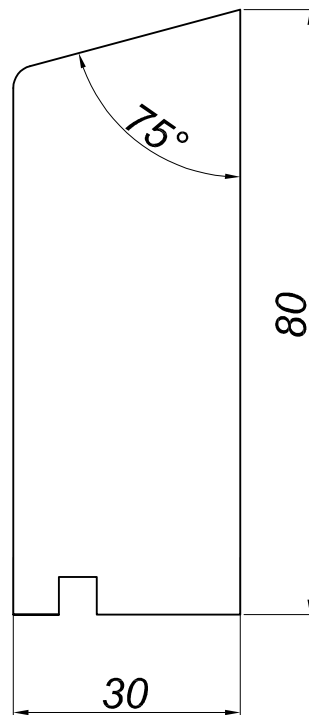
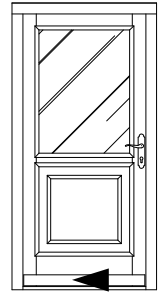
*detal 1-26*

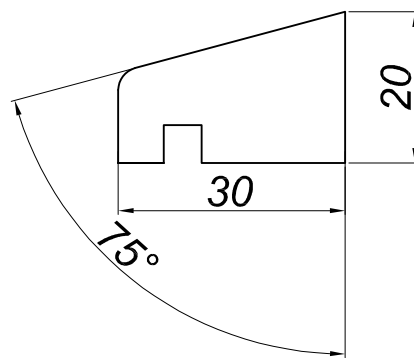
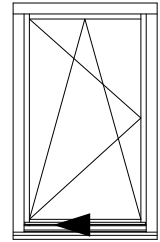
*detal 1-27*

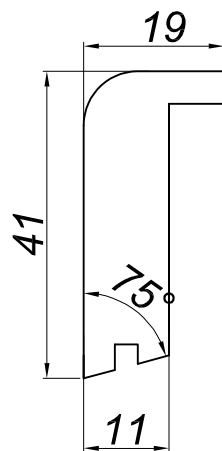
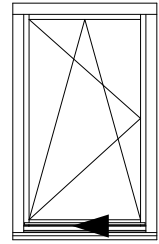
*detal 1-28*

zaczep

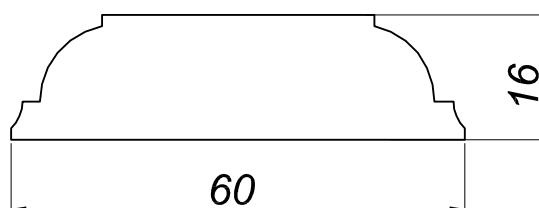
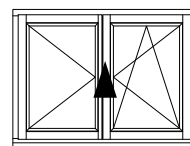

*detal 1-29*

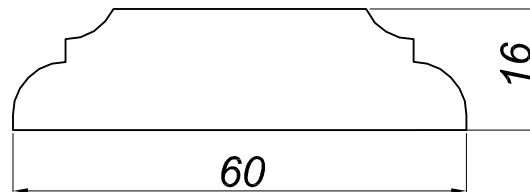
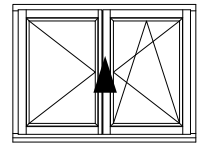
*detal 1-30*

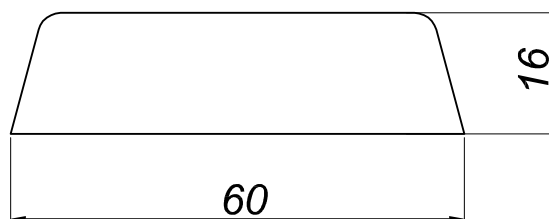
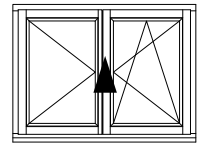
*detal 1-31*

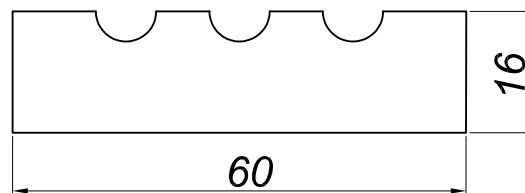
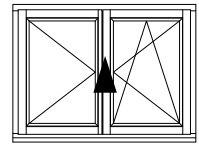
*detal 1-32*

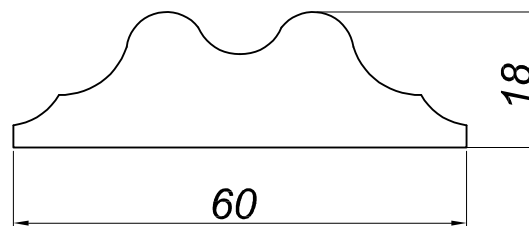
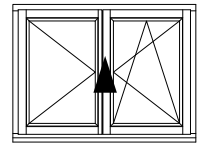

*detal 1-33*

detal 1-34

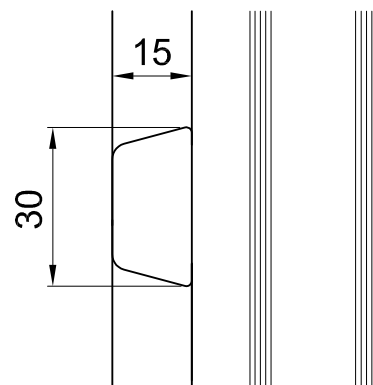
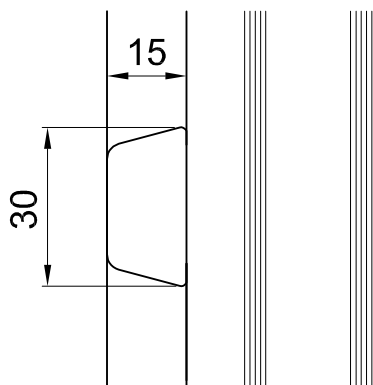
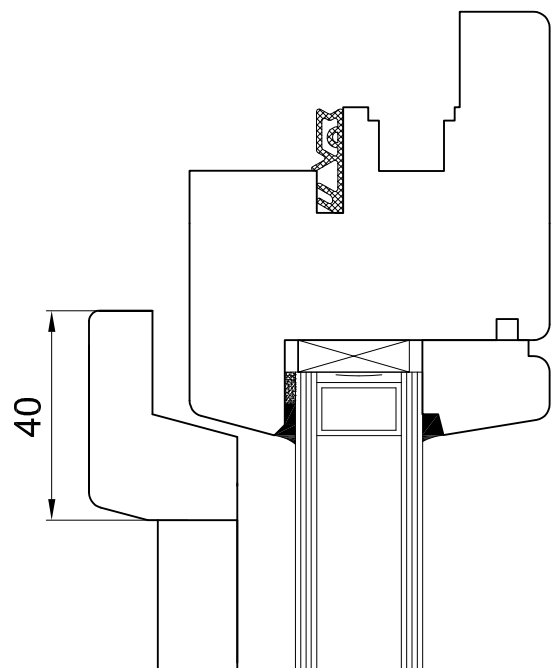
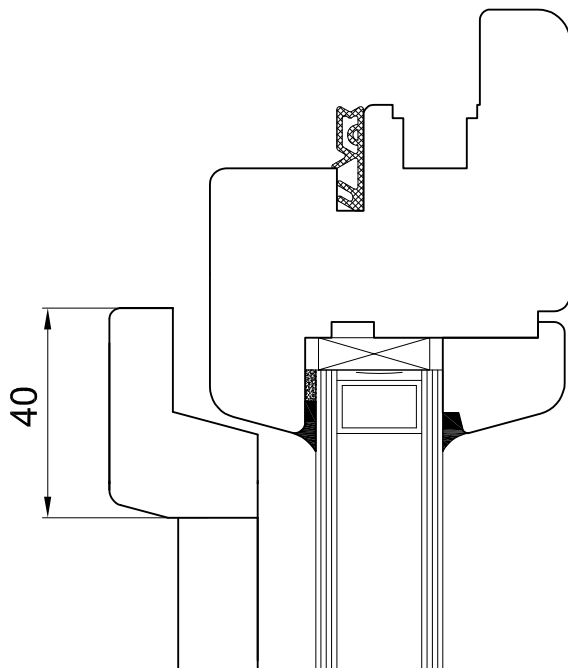
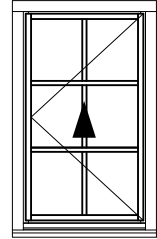

*detal 1-35*

